



Piano in nobilitato
Softforming spessore 2,5 cm.
completo di mensole

** specificare il
cod. colore BI,AC,GR
per il colore del
piano



	P	L	Cod.:		
PRONTA CONSEGNA	36	60	13 03 359C**	<input type="radio"/>	<input type="text"/>
	46	60	13 03 459C**	<input type="radio"/>	<input type="text"/>
PRONTA CONSEGNA	36	100	13 03 399C**	<input type="radio"/>	<input type="text"/>
	46	100	13 03 499C**	<input type="radio"/>	<input type="text"/>
	36	120	13 03 312C**	<input type="radio"/>	<input type="text"/>
	46	120	13 03 412C**	<input type="radio"/>	<input type="text"/>

Portata 60 Kg.

Piano in vetro completo di
mensole



	P	L	Cod.:		
	25	60	VE VT 2560	<input type="radio"/> 10 kg	<input type="text"/>
	35	60	VE VT 3560	<input type="radio"/> 10 kg	<input type="text"/>
	45	60	VE VT 4560	<input type="radio"/> 10 kg	<input type="text"/>
	25	100	VE VT 2510	<input type="radio"/> 10 kg	<input type="text"/>
	35	100	VE VT 35100	<input type="radio"/> 10 kg	<input type="text"/>
	45	100	VE VT 45100	<input type="radio"/> 10 kg	<input type="text"/>
	25	120	VE VT 25120	<input type="radio"/> 10 kg	<input type="text"/>
	35	120	VE VT 35120	<input type="radio"/> 10 kg	<input type="text"/>
	45	120	VE VT 45120	<input type="radio"/> 10 kg	<input type="text"/>

Portata 10 Kg.



Piano in vetro completo di
mensole con supporto
rinforzato

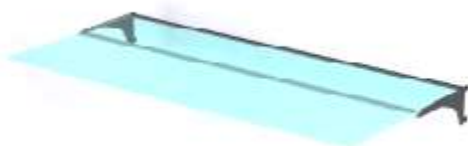

P	L	Cod.:	60 kg	
25 x 60		VE VT 2560R	60 kg	
35 x 60		VE VT 3560R	60 kg	
45 x 60		VE VT 4560R	60 kg	
25 x 100		VE VT 25100R	60 kg	
35 x 100		VE VT 35100R	60 kg	
45 x 100		VE VT 45100R	60 kg	
25 x 120		VE VT 25120R	60 kg	
35 x 120		VE VT 35120R	60 kg	
45 x 120		VE VT 45120R	60 kg	

Portata 60 Kg.

Tutti gli articoli di questa pagina sono PRONTA CONSEGNA



Gancio semplice cromato

cm.

Cod.:

14 54 100 CH

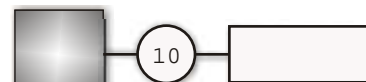

14 54 150 CH

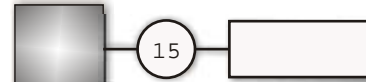

14 54 200 CH

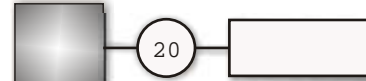

14 54 250 CH



14 54 300 CH

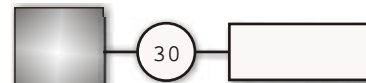

14 54 350 CH

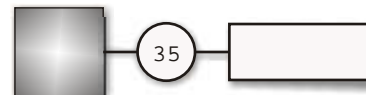

Gancio doppio cromato

cm.

Cod.:

14 55 150 CH



14 55 250 CH



14 55 350 CH



Gancio semplice cromato con portaprezzo in PVC trasparente

cm.

Cod.:

14 56 150PCH



14 56 250PCH



14 56 300PCH

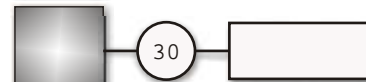

14 56 350PCH

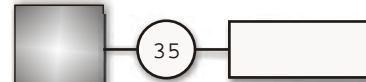

Tutti gli articoli di questa pagina sono PRONTA CONSEGNA

Cod.:

VE BA 1 **

Barra esterna con due appenderie inclinate a 9 posti

Disponibile per elementi da 60, 100 e 120 cm.



** specificare il cod. per la lunghezza della barra

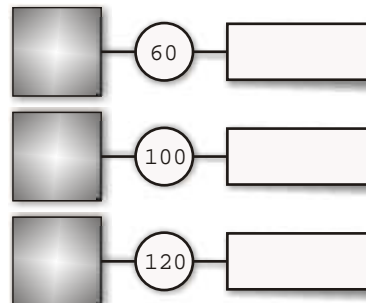

Cod.:

VE BA 2 **

Barra esterna con due appenderie diritte

Disponibile per elementi da 60, 100 e 120 cm.



** specificare il cod. per la lunghezza della barra

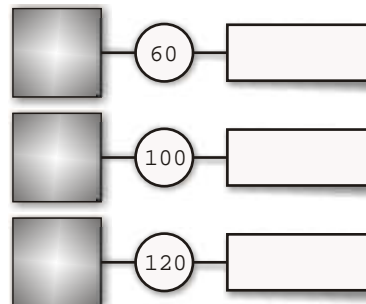

Cod.:

VE BA 3 **

Appendieria ad arco

Disponibile per elementi da 60, 100 e 120 cm. P 30 cm.



** specificare il cod. per la lunghezza della barra

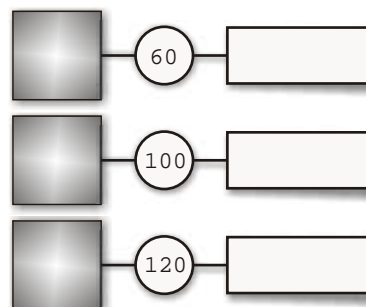

Tutti gli articoli di
questa pagina sono
PRONTA CONSEGNA

**Appenderia inclinate a 9
posti**

N.B. per barra



Cod. :

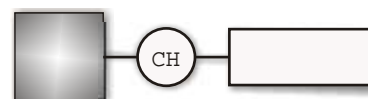

Appenderia diritta

N.B. per Barra



Cod. :

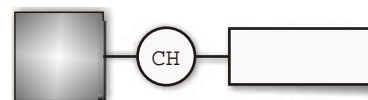

Appenderia esterna

Disponibile per elementi da
60, 100 e 120 cm.



Cod. :

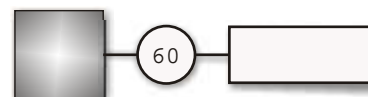

Cod. :

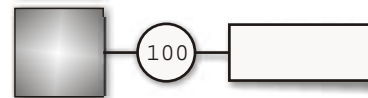

Cod. :

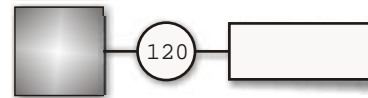

Tutti gli articoli di
questa pagina sono
PRONTA CONSEGNA



Appenderia inclinata a 9
posti per doge

Cod. :
14 12 540 CH

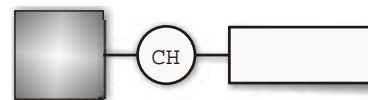

Appenderia diritta per doge

Cod. :
14 16 530 CH

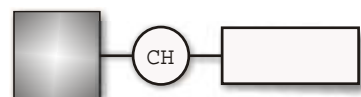

Appenderia a due livelli per
doge

Cod. :
14 17 535 CH

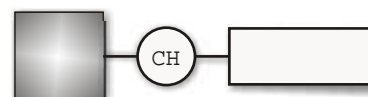

Portacappello per doge

Cod. :
14 28 525 CH

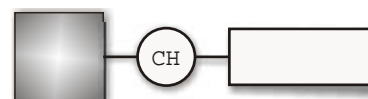



VE MOB 1**

Mobiletto con 2 antine
L 100 x P 46 x H 41

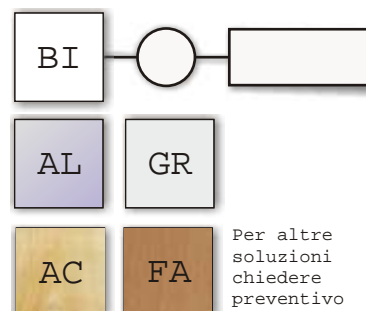

Per altre soluzioni chiedere preventivo



VE MOB 2**

Mobiletto con 2 antine
L 100 x P 46 x H 60 con piano interno

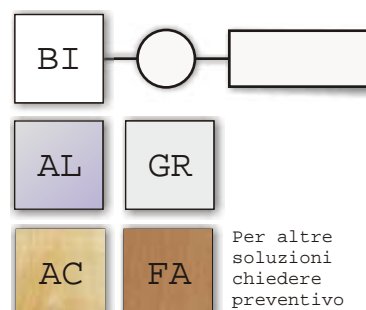

Per altre soluzioni chiedere preventivo



VE MOB 3**

Mobiletto con 2 cassetti
L 100 x P 46 x H 41

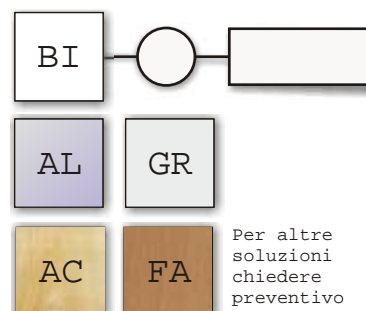

Per altre soluzioni chiedere preventivo



VE MOB 4**

Mobiletto con 3 cassetti
L 100 x P 46 x H 60

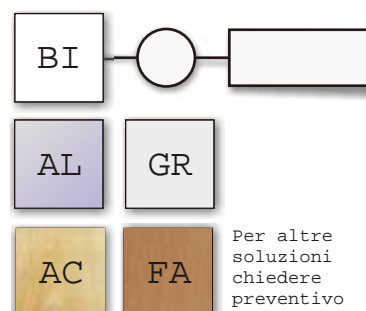

Per altre soluzioni chiedere preventivo



Elementi gondola

SISTEMA XOLEV

Codice:



Elemento gondola 100 x 135

- comprensivo di:
- 2 montanti asolati H 132
 - 2 terminali in PVC
 - 4 basi ad arco
 - 2 piedini di regolazione
 - telaio per pannello
 - 2 traverse di collegamento
 - pannello liscio

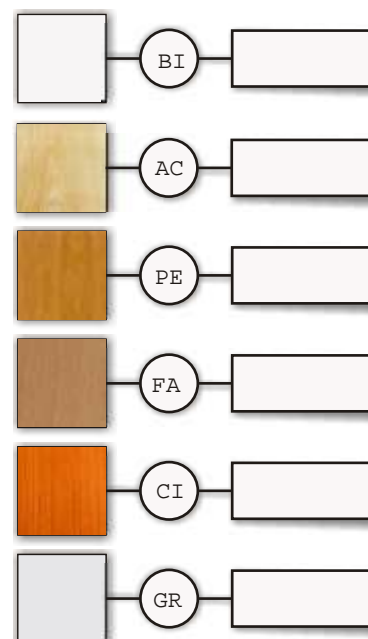

Per altre finiture
chiedere preventivo

Codice:



Elemento gondola 100 x 135

- comprensivo di:
- 2 montanti asolati H 132
 - 2 terminali in PVC
 - 4 basi ad arco
 - 2 piedini di regolazione
 - telaio per pannello
 - 2 traverse di collegamento
 - pannello liscio

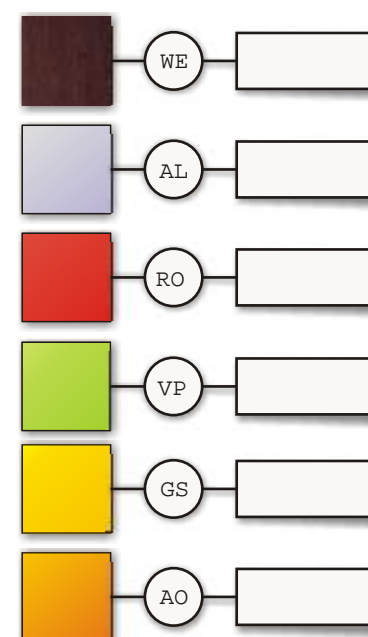

Per altre finiture
chiedere preventivo



Elementi gondola



Codice: VE GON CM8

Elemento 100 x 270

- comprensivo di:
- 3 montanti asolati
 - 6 base ad arco
 - 3 piedino di regolazione a parete
 - 4 traverse di collegamento
 - 2 distanziatore ad incastro
 - 2 telai
 - 2 pannelli lisci
 - 3 terminali in PVC

SISTEMA XOLEV

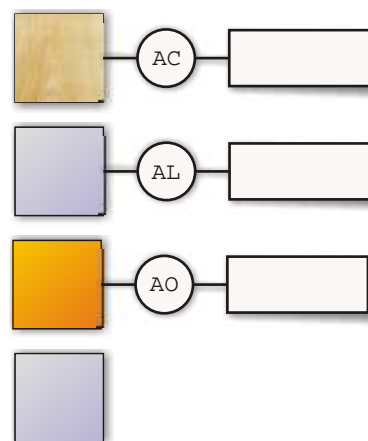

Codice: VE GON C1 **

Elemento gondola 100 x 135

- comprensivo di:
- 2 montanti asolati H 132
 - 2 terminali in PVC
 - 4 basi ad arco
 - 2 piedino di regolazione
 - telaio per pannello
 - 2 traverse di collegamento
 - pannello liscio
 - 6 piani in nobilitato 100 x 36 cm.
 - 6 coppie di mensole alta portata.

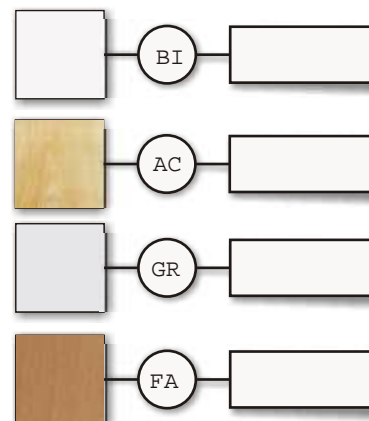

Per altre finiture
chiedere preventivo